

# Installation Manual

Premier Elite Odyssey- W Series

INS595-2



**Texecom**  
Designed to Perform

## Introduction

The **Premier Elite Odyssey-W** sounders are currently available in as; **Premier Elite Odyssey** 1-W,2-W,3-W,4-W & 5-W. With **Ricochet**® mesh technology it is now even easier to add a wireless sounder to your security system. As the device is self powered the only limit on the number of units you can put on a system is determined by how many free **Ricochet** enabled zones you have available.

## System Compatibility

The **Premier Elite Odyssey-W**'s are compatible with all **Premier Elite** control panels V2.11 and later, and **Premier Elite 8XP-W** & **Premier Elite 32XP-W**. **Ricochet** Monitor V2.18.2 or later should also be used.

## Battery Compartment

### 1. Open the Battery Compartment

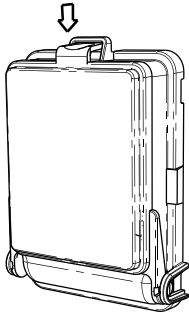

### 2. Removing the lid completely (if required)

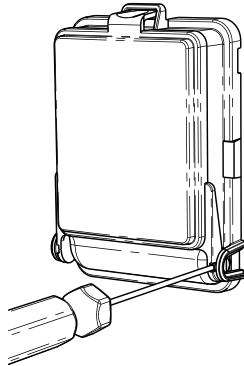

### 3. Install Batteries into Holder

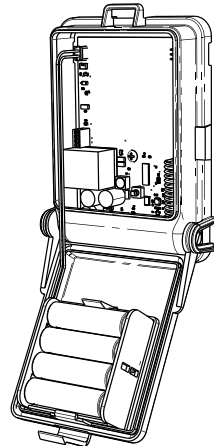

### 4. Clip Holder (bottom first) back into place & connect battery pack to PCB

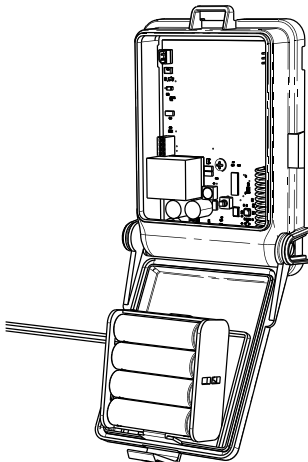

### 5. Learn sounder to panel (if required)

### 6. Make Jumper selection for LED ON/OFF





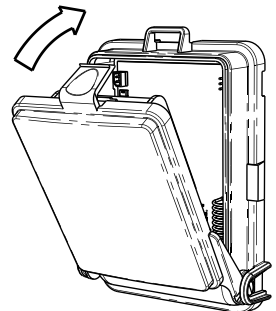

### 7. Make Jumper Selection for Sounder Time

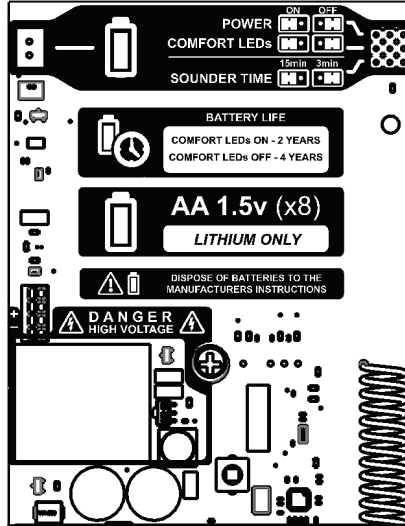
### 8. Close the Battery Compartment



## PCB Layout



Symbol	Description
	The battery pack should be connected here after installing the batteries.
	Powering the sounder on for the first time starts the learn process. Once learned the "POWER" jumper should be left in the "ON" position.  <small>NOTE</small> <i>If you need to relearn the sounder, the link should be moved to the OFF position for a minimum of 1 second.</i>
	Enables or disables the comfort LED's. Disabling the LED's significantly increases battery life.
	The sounder on time is dictated by this jumper position and is independent of the Bell On time in the control panel. If however the panel bell time is shorter than the jumper setting selected, the panel will over ride the jumper setting.
	Only Lithium AA 1.5V Type batteries should be used  <small>NOTE</small> <i>Alkaline batteries should not be used, they will have a much shorter lifespan and can freeze and fail to operate at -5°</i>
	Used Batteries should be disposed of according to the manufacturers instructions.
	The quoted battery life is an estimate and will depend on the site conditions.

## Learning the Sounder

As with all **Ricochet** enabled devices, the sounder should be learned to the control panel along with all other devices BEFORE it is installed in it's final location.

The **Premier Elite Odyssey-W's** are learned to a Zone on the control panel in the same way that **Ricochet** enabled detection devices are. The Zone type and **Ricochet** Device Mode is automatically assigned based on the type of device being learned. In the case of the sounder the Zone Type is set to "Custom" and the **Ricochet** Device Mode is set to Device Specific. These should not be changed. Zone attributes 1 & 2 and Chime options will be ignored for **Ricochet** enabled Sounders.

- You can learn the device from first power up following "**Confirm Devices**" or from the dedicated **Ricochet** Learn menu.
- The Odyssey-W has no Learn Switch, learning is initiated by connecting the batteries via the Power Jumper
- To learn the Odyssey-W to the system follow the diagram below.

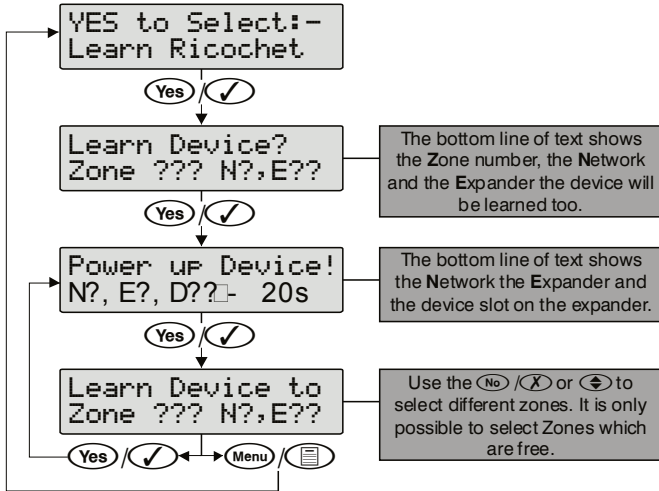

## LED Indications

The Odyssey-W LED,s aid in the installation of the device and act as status indicators. The table below details the status of each LED indicator.



The LED jumper has no effect on the status described below.

Leds	Status
Left LED flashing quickly	Device is attempting to communicate with receiver after power up.
Left LED flashing slowly	Device has learnt or re-connected to receiver and is waiting for the tamper to be closed.
Both LEDs off	Device has failed to learn or failed to communicate after tamper has been closed.
Right LED flashing quickly	Device is attempting to communicate with receiver after tamper has been closed.
Right LED on solid (for 3 seconds)	Device has successfully connected with receiver after tamper closed.
Right LED flashing slowly	Holdoff mode has been requested from the panel but the tamper is closed. Bell will not self-activate. Cancels after 20 minutes.
LEDs alternating quickly.	Device has successfully connected with receiver after tamper closed and self-activation on tamper will re-activate in 2 minutes.

## Hold Off Mode

For safety reasons, each Texecom sounder and strobe unit incorporates a unique patented engineer Hold-Off mode. This mode prevents the unit from self-activating during installation and maintenance, thereby allowing only bona fide engineers access to the unit without any loss of tamper protection. The sounder can be put in hold-off mode by flashing the strobe 3 times.

When the outer cover is replaced and the tamper circuit is closed, the LEDs will alternate rapidly, confirming that the tamper circuit is secure and signalling that self activation on tamper will be re-enabled within 2 minutes, after which the LEDs will alternate slowly to signal normal operation. If the tamper circuit is re-opened within the 2 minute period, then Hold-Off mode will be restored.



*The LED's will only flash after hold of mode has stopped IF the LED jumper is in the "ON" position.*



*The strobe is disabled during Hold-Off mode. Hold-Off mode is immediately cancelled when the sounder is activated from the control panel if the tamper is closed..*

## Mounting the Unit

Select a suitable position to mount the unit, which satisfies the following criteria:

- Good wireless signal



*The wireless signal may be checked before final installation by depressing the tamper switch briefly. The Right LED will flash to indicate communication and will go solid for 3 seconds to indicate a successful connection.*

- Highly prominent for maximum deterrence
- Additional shelter (e.g. under the eaves) is an advantage
- High enough to be out of normal reach to deter tampering
- Safe ladder access

In addition to the corner screw fixing points, the unit also has a central keyhole to simplify mounting and aid levelling.

Four screws and wall plugs are required for mounting the backplate to an even surface.



*An additional screw is required to provide "Removal from Mounting" tamper and is required in installations complying with the requirements PD6662 and/or EN50131. In doing so, care must be taken to leave the screw head slightly proud to ensure that the microswitch remains level and closes correctly when the outer cover is fitted.*



*For maximum weatherproofing the unit should be flat to the wall.*

## Rear Tamper

**Odyssey 1 Rear Tamper**

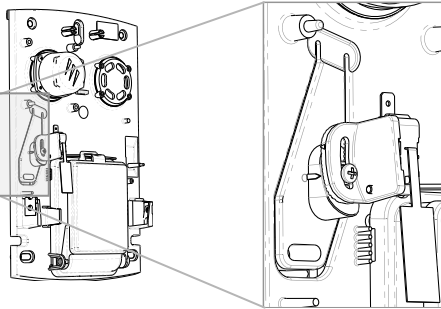

**Odyssey 2 Rear Tamper**

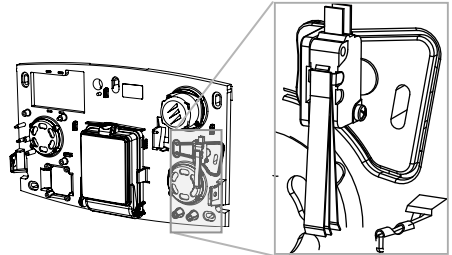

**Odyssey 3 Rear Tamper**

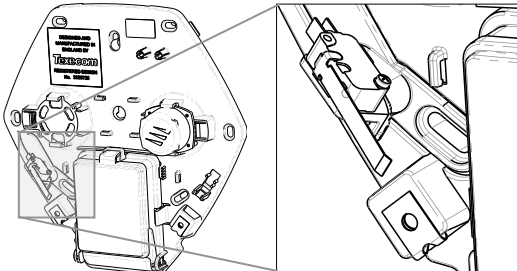

**Odyssey 4 Rear Tamper**

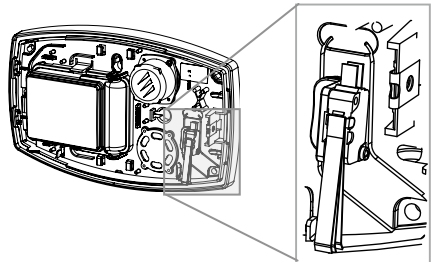

### Odyssey 5 Rear Tamper

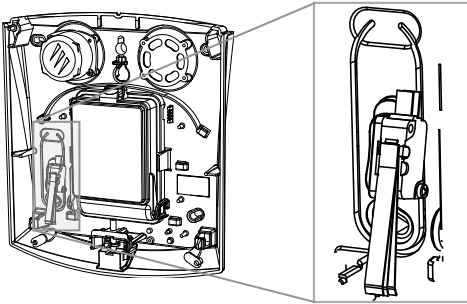

### Adjusting Tamper Sensitivity

If greater wall/lid tamper sensitivity is required, the microswitch position can be adjusted by loosening the locking screw and altering the orientation of the microswitch as shown.

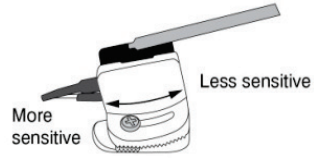

## Installing The Cover

*Premier Elite Odyssey 1-W*

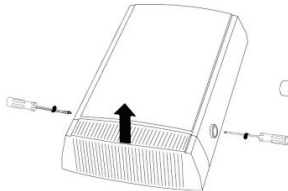

*Premier Elite Odyssey 2-W*

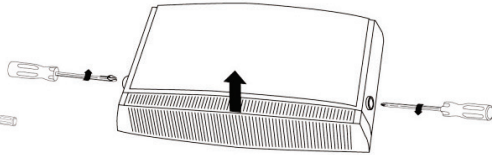

*Premier Elite Odyssey 3-W*

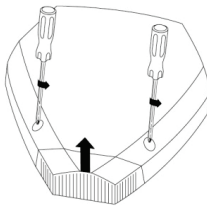

*Premier Elite Odyssey 4-W*

Screw retained  
in backplate.

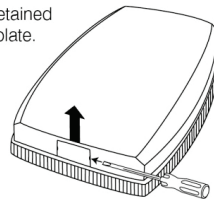

*Premier Elite Odyssey 5-W*

Screw retained  
in backplate.

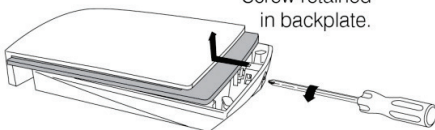

## Commissioning

Once the installation is complete the sounder should be tested to confirm correct operation. This can be achieved by utilising the Bell/Strobe test facility in the "Engineer Utilities" menu.

## Technical Specification

### Environmental

**Volume** 105dB Peak at 1m (A Weighting, 90°)

**Acoustic Output** Varying Sound Output  
**Cut-Off Time:** ≤15 minutes or ≤3 minutes(selectable)  
**Waterproof Coating:** Conformal  
**Environmental Protection** IP65

**Operating Temperature:** -25°C (-13°F) to +55°C (+131°F)\*\*  
**Storage Temperature:** -25°C (-13°F) to +60°C (+140°F)  
**EMC Environment:** Residential / Commercial /Light Industrial / Industrial

\* The flash rate will reduce to 0.125Hz after flashing for 20 minutes (1 flash every 8 seconds). This is a software feature to reduce power consumption and cannot be disabled. After 10 days the strobe is cancelled completely. Turning the strobe off then on again will resume normal operation.

\*\* In extreme conditions where the temperature is likely to exceed the stated maximum avoid direct sunlight.

### Electrical

**Supply Voltage:** 12V DC  
**Battery Type:** 8 x Lithium type AA 1.5V  
**High Power LED Strobe:** 320lm  
**Flash Rate:** 1Hz (typical)\*  
**Comfort LEDs:**  
 Brightness: 100mcd (typical)  
 Flash Rate (tamper secure): 1/4 sec flash at 5 sec intervals alternating (typical)  
**Wireless Frequency:** 868.0MHz – 868.6MHz

### Physical

Material	3mm polycarbonate	Packed Weight	
<b>Tamper Detection</b>	Wall & Lid	<i>Premier Elite Odyssey 1-W</i>	840g approx
<b>Dimensions (h x w x d)</b>		<i>Premier Elite Odyssey 2-W</i>	980g approx
<i>Premier Elite Odyssey 1-W</i>	318mm x 201mm x 66.5mm	<i>Premier Elite Odyssey 3-W</i>	890g approx
<i>Premier Elite Odyssey 2-W</i>	242mm x 382mm x 76mm	<i>Premier Elite Odyssey 4-W</i>	730g approx
<i>Premier Elite Odyssey 3-W</i>	315mm x 306mm x 78mm	<i>Premier Elite Odyssey 5-W</i>	920g approx
<i>Premier Elite Odyssey 4-W</i>	310mm x 196mm x 58.5mm		
<i>Premier Elite Odyssey 5-W</i>	284 mm x 256 mm x 68 mm		

### Standards



2004/108/EC (CE directive): Hereby, Texecom declares that this device is in compliance with the essential requirements and other relevant provisions of Directive 2004/108/EC.

**WEEE Directive:** 2002/96/EC (WEEE directive): Products marked with this symbol cannot be disposed of as unsorted municipal waste in the European Union. For proper recycling, return this product to your local supplier upon the purchase of equivalent new equipment, or dispose of it at designated collection points. For more information see: [www.recyclethis.info](http://www.recyclethis.info).

**RoHS Directive:** 2002/95/EC RoHS Compliant. Hereby, Texecom declares that this device does not contain lead, mercury, cadmium, hexavalent chromium, polybrominated biphenyls (PBB) or polybrominated diphenyl ethers (PBDE) in more than the percentage specified by EU directive 2002/95/EC, except exemptions stated in EU directive 2002/95/EC annex.

This product is a Type B Moveable device and is suitable for use in systems designed to comply with EN 50131-1, EN50131-3, EN50131-5-3 and PD6662 at Grade 2 and Environmental Class II.

### Security Grade 2 Environmental Class 2

EN Standard	<i>Premier Elite Odyssey-W</i>
EN60950-1	✓
EN61000-6-3	✓
EN 301 489-3	✓
EN50130-4	✓
EN300 220-1	✓
EN50131-1	✓
EN50130-5	✓
EN50131-5-3	✓
EN50131-6	✓
PD6662	✓
EN50131-4	✓

### Warranty

All Texecom products are designed for reliable, trouble-free operation. Quality is carefully monitored by extensive computerised testing. As a result the *Premier Elite Odyssey -W* are covered by a two year warranty against defects in material or workmanship (details on request).

Because the *Premier Elite Odyssey -W Series* are not complete alarm systems but only a part thereof, Texecom cannot accept responsibility or liability for any damages whatsoever based on a claim that a unit failed to function correctly. Due to our policy of continuous improvement Texecom reserve the right to change specification without prior notice.

*Odyssey* is a trademark of Texecom Ltd.

*Premier* & *Premier Elite* are trademarks of Texecom Ltd

# **Texecom**

## **Designed to Perform**

Texecom Limited, Bradwood Court, St. Crispin Way, Haslingden, Lancashire BB4  
4PW, England.

### **Technical Support:**

UK Customers Tel: 08456 300 600

(Calls charged at 3.36 pence per minute from a BT landline. Calls from other networks may vary.)

International Customers Tel: +44 1706 233875

Email: [techsupport@texe.com](mailto:techsupport@texe.com)

© Texecom Limited 2014

**INS595-2**



Certificate Number: FM 35285