

Features:

- Switch 6 ports
4 PoE ports 10/100/1000Mb/s (data transfer and power supply)
2 ports 10/100/1000Mb/s (UpLink)
- 30W for each PoE port, supports devices compliant with the IEEE802.3af/at (**PoE+**) standard
- Supports auto-learning and auto-aging of MAC addresses (1K size)
- LED indication
- Pole mounting option (requires the OZB2 adapter - **optional accessory**)
- Built-in switch mode power supply PSCL520115 52VDC/1,15A/60W
- Protections:
 - SCP short circuit protection
 - OLP overload protection
 - surge protection (AC input)
- IP56 hermetic enclosure
- warranty – 1 year from the production date

Example of use.

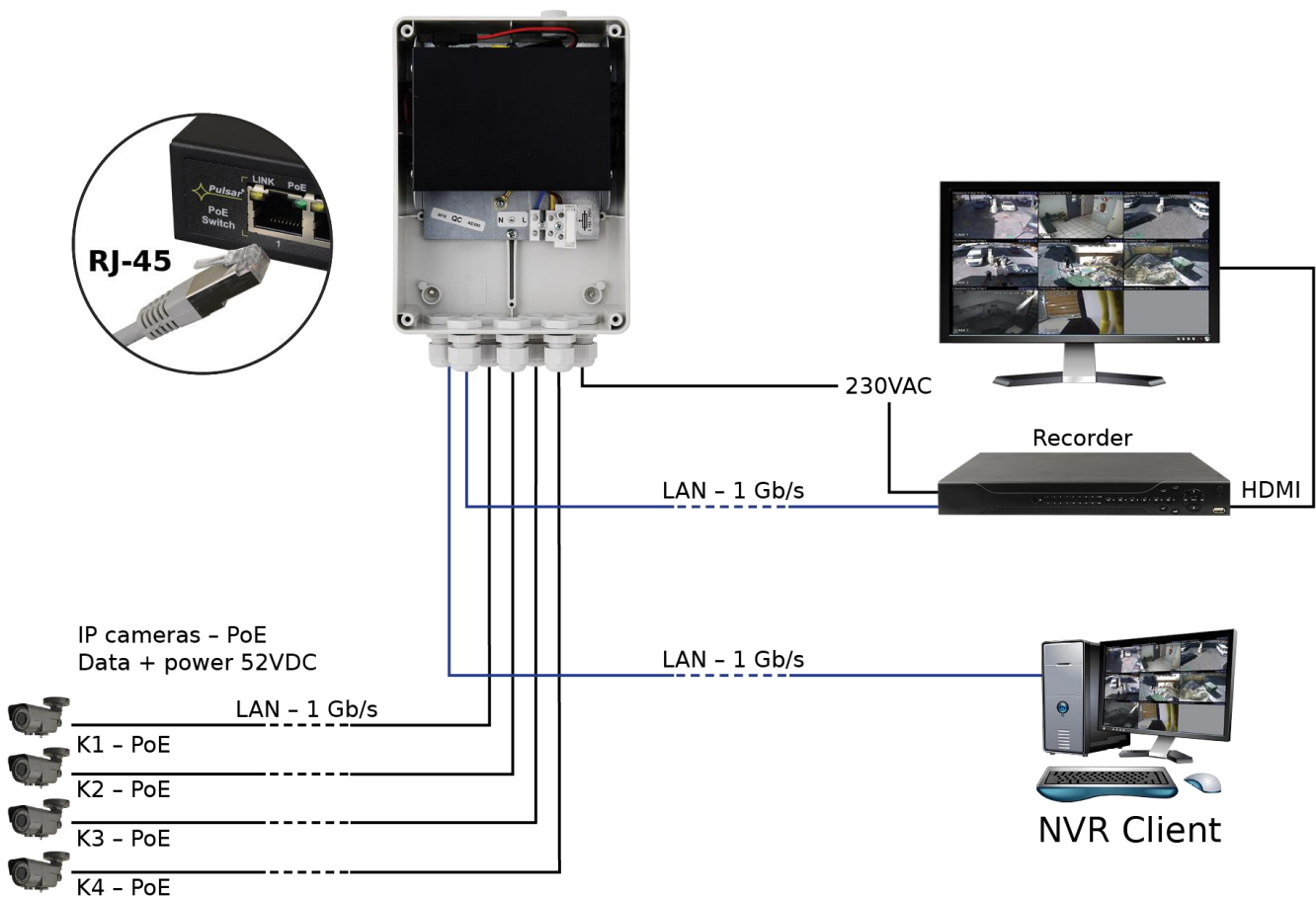

1. Technical description

1.1. General description.

SG64H is a 6-ports PoE switch designed to supply IP cameras operating in IEEE 802.3af/at standard. Automatic detection of any devices powered in the PoE/PoE+ standard is enabled at the 1 – 4 ports of the switch. The UpLink ports is used for connection of another network device via RJ45 connector. The LEDs at the front panel indicate the operation status (description in the table below).

The PoE technology ensures a network connection and reduces installation costs by eliminating the need to supply a separate power cable for each device. This method allows supplying other network devices, such as IP phone, wireless access point or router.

1.2 Block diagram.

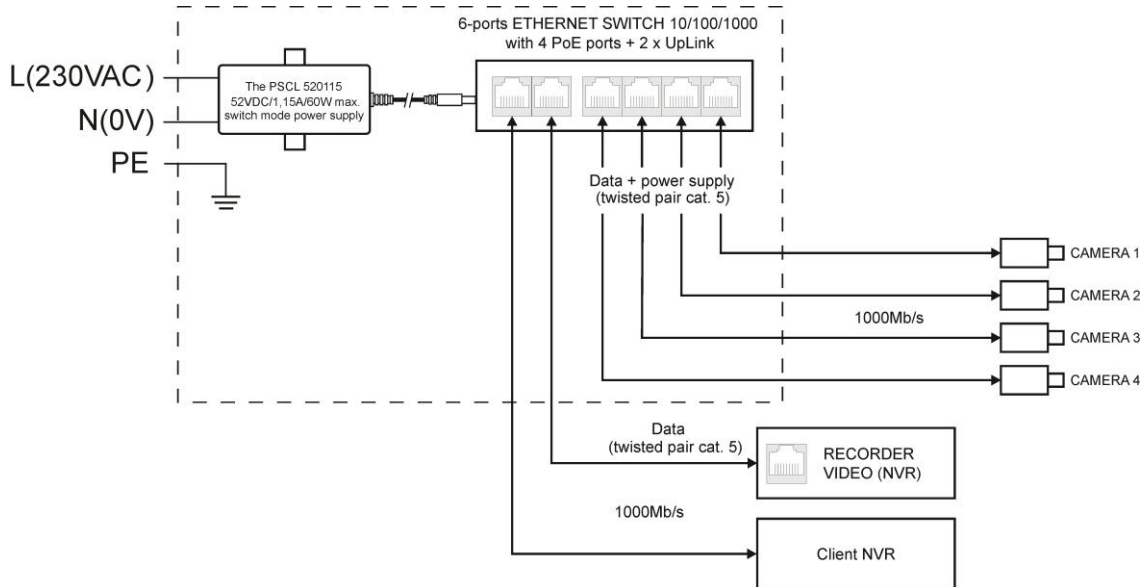

Fig. 1. Block diagram.

1.3. Description of components and connectors.

Table 1. (see Fig.2)

Element no. (Fig. 2)	Description
[1]	Pressure Compensator
[2]	PoE switch
[3]	Power supply connector of the PSU – L, N PE protective connector (electric shock)
[4]	F _{MAINS} fuse in the supply circuit (230VAC)
[5]	Cable glands

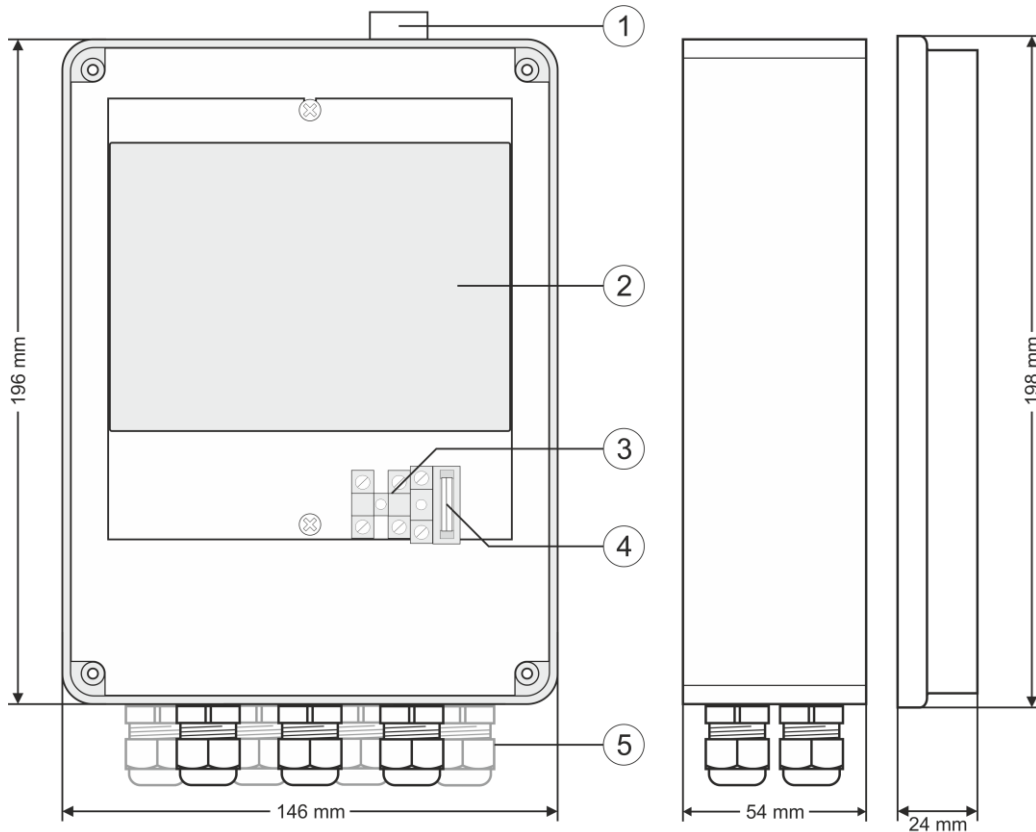

Fig. 2. The enclosure view.

Table 2. (see Fig. 3)

Element no. (Fig. 2)	Description
[1]	2 x UpLink ports
[2]	4 x PoE ports (1÷4)
[3]	DC power supply socket

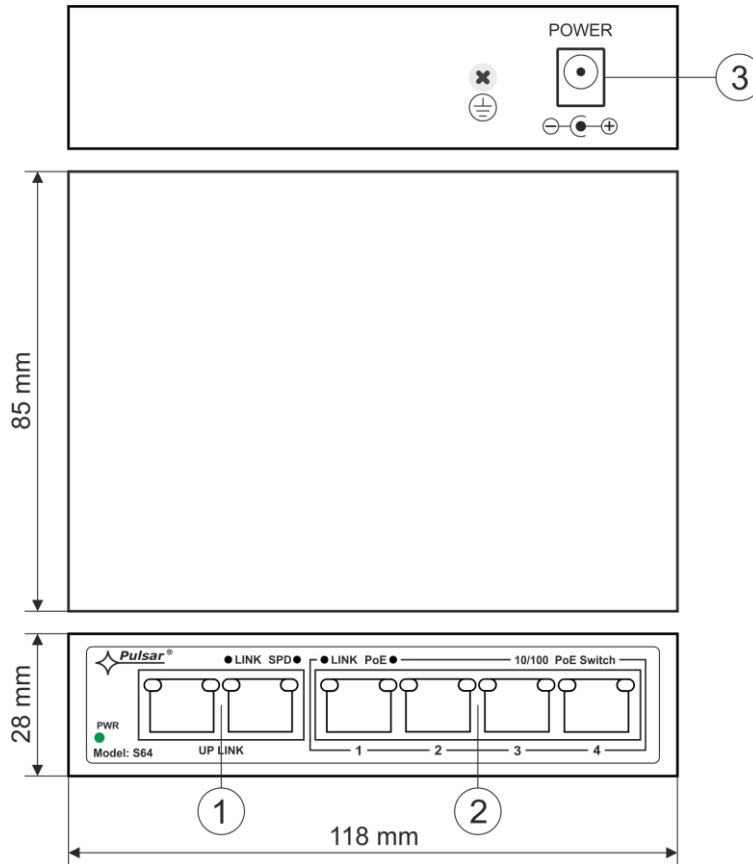

Fig. 3. The view switch'a.

1.4. Technical parameters.

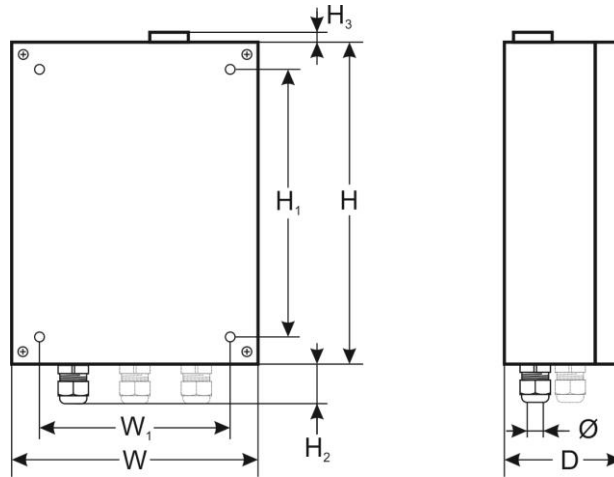

Table 3.

Ports	6 10/100/1000Mb/s ports (4 x PoE + 2 x UpLink) with connection speed auto-negotiation and MDI/MDIX Auto Cross
PoE power supply	IEEE 802.3af/at (1÷4 ports), 52VDC / 30W at each port * Used pairs 4/5 (+), 7/8 (-)
Protocols, Standards	IEEE802.3, 802.3u, 802.3x CSMA/CD, TCP/IP
Bandwidth	8,8Gbps
Transmission method	Store-and-Forward
Optical indication of operation	Switch power supply; Link/Act; PoE Status

Short circuit protection SCP	electronic, automatic recovery
Overload protection OLP	150%-200% PSU power, automatic recovery
Power supply	90 ÷ 264VAC 50÷60Hz / 0,5A / 230VAC switched mode power supply PSCL520115 52VDC / 1,15A/60W max.
F_{MAINS} fuse	T3,15A / 250V
Operating conditions	temperature -10°C ÷ 40°C, relative humidity 5% - 90%, no condensation
External dimensions	W=146, H=196, D=78 [+/- 2mm]
Mounting dimensions	W ₁ =105, H ₁ =155 [+/- 2mm]
Height glands	H ₂ =25mm
Height of the pressure compressor	H ₃ =9 [mm]
The number of cable glands/ Ø cables	7 pcs. / 4÷8mm
Enclosure	IP56, light grey
Additional equipment	plate to be fixed surface
Net/gross weight	1,2 / 1,3kg
Protection class EN 60950-1:2007	I (first)
Storage temperatur	-25°C÷50°C
Declarations	CE

* The given value of 30W per port is the maximum value. The total power consumption should not exceed 30W when all PoE ports are being used.

2. Installation

2.1. Requirements



The switch should be mounted by a qualified installer, holding relevant permits and licenses (applicable and required for a given country) for low-voltage installations. The device should be mounted in a place protected from weather conditions and direct sun, with temperatures from -25°C to + 50°C. Thanks to the use of the OZB2 mounting plate (optional accessory), it is possible to mount the device on a pole (not included).

The load balance should be done before installation Switcha. The given value of 30W per port is the maximum value referring to a single output. The total power consumption should not exceed 30W when all PoE ports are being used. The increased demand for power is particularly evident in the case of cameras with heaters or infrared illuminators - when launching these features, the power consumption increases rapidly, which may adversely affect the operation of the switch. The device is designed for a continuous operation and is not equipped with a power-switch. Therefore, an appropriate overload protection in the power supply circuit should be provided. The electrical system shall be made in accordance with applicable standards and regulations.

2.2. Installation procedure

1. **Before installation, cut off the voltage in the 230V power-supply circuit.**
2. Mount the PSU in a selected location and connect the wires (tighten cable glands - unused should be plugged).
3. Connect the power cables (~230Vac) to L-N clips of the PSU. Connect the ground wire to the terminal marked with the  symbol (power supply module connector). Use a three-core cable (with a yellow and green PE protection wire) to make the connection).



The shock protection circuit shall be performed with a particular care, i.e. the yellow and green wire coat of the power cable shall stick to one side of the terminal - marked with '' symbol on the PSU enclosure.  Operation of the PSU without the properly made and fully operational shock protection circuit is UNACCEPTABLE! It can cause a device failure or an electric shock.

4. Connect the camera wires to the RJ45 connectors (PoE connectors).
5. Connect the power (~230V).
6. Check the optical indication of the switch operation (see Table 4).
7. After installing and checking proper working, the enclosure can be closed.

Connection schemes.

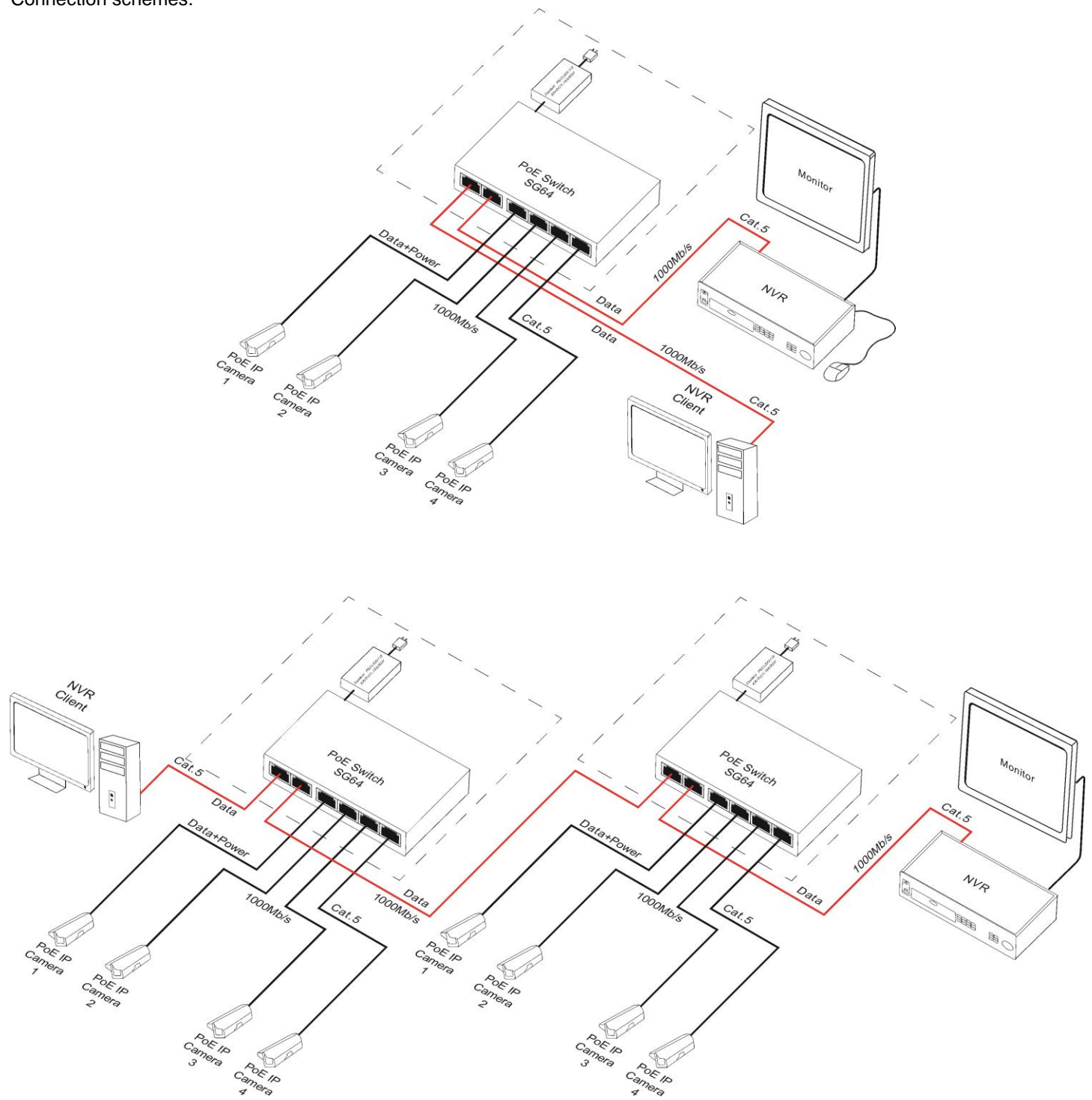



3. Operation indication.

Table 4. Operation indication



OPTICAL INDICATION OF THE SWITCH's POWER SUPPLY

GREEN LED LIGHT (Power) Indication of the switch's power supply	PWR 	OFF – no power supply of the switch ON – power supply on, normal operation
---	--	---

OPTICAL INDICATION AT THE PoE PORTS (1÷4)

GREEN LED LIGHT (PoE) Indication of the PoE power supply at the RJ45 ports		OFF - no power supply at the RJ45 port (the device is not connected or not compliant with the IEEE802. 3af/at standard) ON – supply at the RJ45 port Blinking – short-circuit or output overload
YELLOW LED LIGHT (LINK) The connection status of LAN devices, 10/100/1000Mb/s and data transmission		OFF - no connection ON - the device is connected; 10/100/1000Mb/s Blinking – data transmission

OPTICAL INDICATION AT THE UP LINK PORTS

GREEN LED LIGHT		OFF - no connection/ the device is connected; 10/100Mb/s ON – the device is connected; 1000Mb/s
YELLOW LED LIGHT (LINK) The connection status of LAN devices, 10/100/1000Mb/s and data transmission		OFF - no data transmission ON - the device is connected; 10/100/1000Mb/s Blinking – data transmission



WEEE LABEL

Waste electrical and electronic equipment must not be disposed of with normal household waste. According to the European Union WEEE Directive, waste electrical and electronic equipment should be disposed of separately from normal household waste.

Pulsar

Siedlec 150, 32-744 Łapczyca, Poland
 Tel. (+48) 14-610-19-40, Fax. (+48) 14-610-19-50
 e-mail: biuro@pulsar.pl, sales@pulsar.pl
 http:// www.pulsar.pl, www.zasilacze.pl