

DS-2CE50D8T-VPITFS#EU 2MP Ultra Low Light Fixed Dome Camera



- High quality imaging with 2 MP, 1920 × 1080 resolution
- F1.0 aperture
- Clear imaging against strong back light due to 130 dB true WDR technology
- 3D DNR technology delivers clean and sharp images
- 2.8 mm fixed focal lens
- Up to 40 m IR distance for bright night imaging
- High quality audio with audio over coaxial cable, built-in mic
- One port for four switchable signals (TVI/AHD/CVI/CVBS)
- Water and dust resistant (IP67) and vandal resistant (IK10)

▪ Specification

| Camera | |
|--------------------------|---|
| Image Sensor | 2 MP CMOS |
| Max. Resolution | 1920 (H) × 1080 (V) |
| Slow Shutter | Max. 16 times |
| Min. Illumination | 0.0005 Lux @ (F1.0, AGC ON), 0 Lux with white light |
| Day & Night | ICR |
| Angle Adjustment | Pan: 0 to 355°, Tilt: 0 to 75°, Rotation: 0 to 355° |
| Signal System | PAL/NTSC |
| Shutter Time | PAL: 1/25 s to 1/50,000 s; NTSC: 1/30 s to 1/50,000 s |
| Lens | |
| Lens Type | 2.8 mm fixed focal lens |
| Focal Length & FOV | 2.8 mm, horizontal FOV: 105°, vertical FOV: 56°, diagonal FOV: 123° |
| Lens Mount | M12 |
| Illuminator | |
| Supplement Light Type | IR |
| Supplement Light Range | IR: Up to 40 m |
| Image | |
| Image Parameters Switch | STD/HIGH-SAT |
| Image Settings | Brightness, Contrast, Sharpness, Anti-banding, AGC |
| Frame Rate | TVI: 1080p @30 fps, 1080p @25 fps AHD: 1080p @30 fps, 1080p @25 fps CVI: 1080p @30 fps, 1080p @25 fps CVBS: PAL/NTSC |
| Day/Night Mode | Auto |
| Wide Dynamic Range (WDR) | ≥130 dB |
| Image Enhancement | WDR, BLC, HLC, Global, HLS |
| Privacy Mask | 4 programmable privacy masks |
| Noise Reduction | 3D DNR |
| White Balance | Auto, Manual |
| Interface | |
| Video Output | Switchable TVI/AHD/CVI/CVBS |

| | |
|---------------------|--|
| Built-in Microphone | Yes |
| Event | |
| Motion Detection | 4 programmable motion areas |
| General | |
| Power | 12 VDC \pm 25%, max.6.9 W, *You are recommended to use one power adapter to supply the power for one camera. |
| Material | Metal |
| Dimension | \varnothing 121.5 mm \times 97.6 mm (\varnothing 4.78" \times 3.84") |
| Weight | Approx. 510 g (1.12 lb.) |
| Operating Condition | -40 °C to 60 °C (-40 °F to 140 °F). Humidity 90% or less (non-condensing) |
| Communication | HIKVISION-C |
| Language | English |
| Approval | |
| Protection | IP67, IK10 |

▪ Available Model



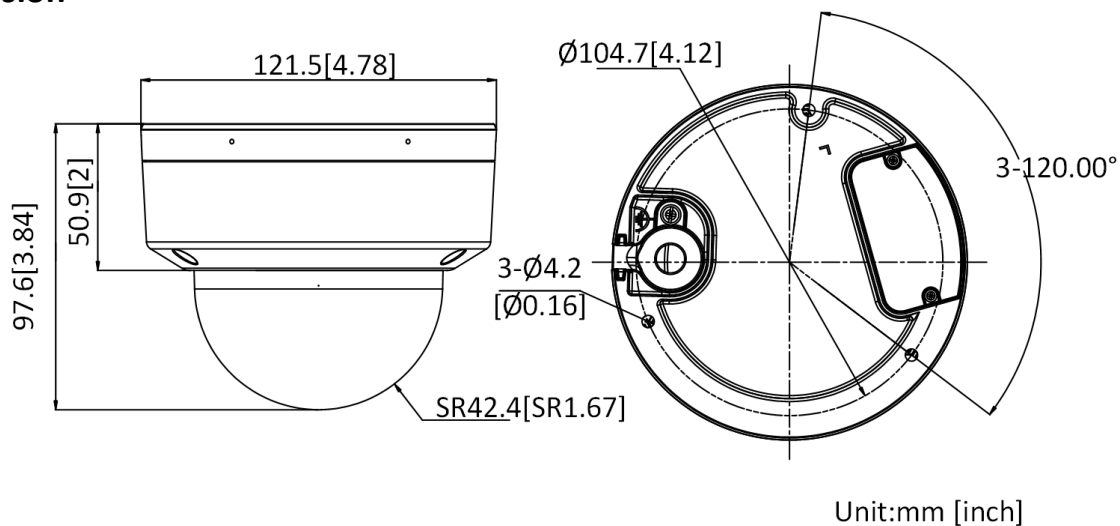

DS-2CE50D8T-VPITFS(2.8mm)(HIK Europe)

▪ Dimension

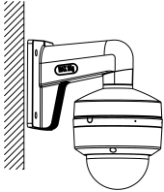
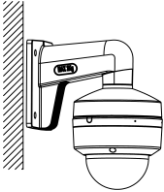

▪ Accessory

▪ Optional

| DS-1272ZJ-120 Wall mount | DS-1272ZJ-120B Wall mount | DS-1271ZJ-120 Pendant Mount |
|---|---|---|
|  |  |  |
|  |  |  |

Headquarters

No.555 Qianmo Road, Binjiang District,
Hangzhou 310051, China
T +86-571-8807-5998
www.hikvision.com



Follow us on social media to get the latest product and solution information.

